

S E N S I T E R R E

Matteo Thun
MILANO

FORIM

UN'EDIZIONE LIMITATA DI VASI IN
TERRACOTTA NATA NEL 2014 E
REALIZZATA CON BITOSSI, PRENDE IL
NOME DALLA DONNA IDEALE: VENERE
BIANCA. REALIZZATI A MANO DA MAESTRI
CERAMISTI IN TOSCANA, I VASI SONO PEZZI
UNICI CHE COMUNICANO EMOZIONE
E TATTILITÀ E CHE RICHIAMANO LA
BELLEZZA DELL'ARTIGIANATO DELLE
BOTTEGHE RINASCIMENTALI ITALIANE.
LA COLLEZIONE VENERE BIANCA,
DISEGNATA DA MATTEO THUN E
BENEDETTO FASCIANA, VIENE CELEBRATA
E TRASFORMATA NELLA NUOVA
COLLEZIONE FLORIM, SENSI TERRE.





A LIMITED EDITION OF TERRACOTTA
VASES IN HONOR OF THE IDEAL
WOMAN, VENERE BIANCA, WAS BORN
IN 2014 BY BITOSSI. HAND-MADE BY
MASTER POTTERS IN TUSCANY, THE
VASES BECAME UNIQUE OBJECTS
COMMUNICATING EMOTION AND
TACTILITY THAT REINSTATE THE
BEAUTY OF CRAFTSMANSHIP FROM
ITALIAN RENAISSANCE WORKSHOPS.
THE VENERE BIANCA COLLECTION,
DESIGNED BY MATTEO THUN AND
BENEDETTO FASCIANA, IS CELEBRATED
AND TRANSFORMED INTO THE NEW
FLORIM COLLECTION, SENSITERRE.

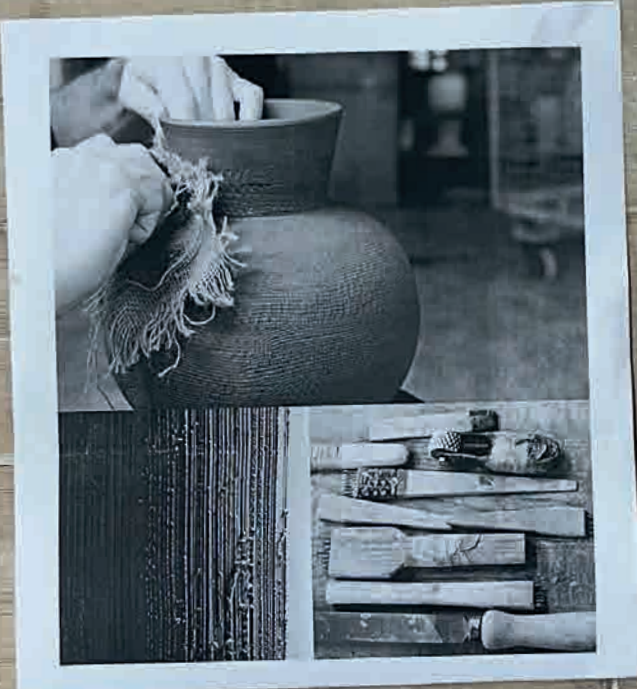





VENERE BIANCA by Bitossi, 2015



THE COLLECTION

S E N S I T E R R E

FLORIM, Matteo Thun e Benedetto Fasciana indagano le potenzialità estetiche di una materia senza tempo, straordinaria espressione della cultura artigianale italiana. I designers esprimono così la loro profonda ammirazione per l'eccellenza del "Made in Italy" attraverso la collezione SensiTerre, imprimendo fascino e tattilità alla ceramica tradizionale coadiuvati da un supporto tecnologico e dalla intensa ricerca di una essenzialità poetica. Il percorso progettuale trova origine nella Venere Bianca che in occasione del suo decimo anniversario viene declinata sulle superfici ceramiche, mantenendo saldo il legame con la terracotta e la sua unicità/purezza. Sei tonalità evocano la terra e quattro superfici le contraddistinguono, invitando la mano a cercare il contatto con la materia creando un dialogo tra memoria e design. La modularità e le configurazioni multiple sono elementi chiave di questa collezione, interprete di una espressione creativa dalle infinite possibilità. È così che SensiTerre approfondisce il dialogo iniziato con Sensi per l'esplorazione della materia, da toccare con gli occhi e vedere attraverso il tatto.

FLORIM, Matteo Thun and Benedetto Fasciana explore the aesthetic potential of a timeless material, an extraordinary expression of Italian craftsmanship. The designers express their deep admiration for the excellence of 'Made in Italy' through the SensiTerre collection, infusing traditional ceramics with charm and tactility, aided by technological support and an intense search for poetic simplicity. The design journey originates from the Venere Bianca, which, on its tenth anniversary, is applied to ceramic surfaces, maintaining a strong connection with terracotta and its uniqueness/purity. Six shades evoke the earth, and four surfaces distinguish them, inviting the hand to seek contact with the material, creating a dialogue between memory and design. Modularity and multiple configurations are key elements of this collection, interpreting a creative expression with infinite possibilities. Thus, SensiTerre deepens the dialogue begun with Sensi for the exploration of material, to be touched with the eyes and seen through touch.

COLOURS

SensiTerre è disponibile in una palette di sei colori caldi e ispirati alla terra: cotone, sabbia, rosato, mattone, amaranto e carbone. Ogni tonalità rappresenta una scelta cromatica unica e a sé.

SensiTerre is available in a palette of six warm and earthy colours:
cotton, sand, pinkish, brick, reddish purple and coal.
Each tone stands for a strong and unique chromatic choice.

COTONE

SABBIA

ROSATO

MATTONE

AMARANTO

CARBONE

SURFACES

La collezione presenta quattro tipologie di superfici,
tutte caratterizzate da una sensazione naturale
e da una combinazione di tattilità e sensorialità:
Naturale, Grana, Rigatino e Cannettato.

The collection display four different surfaces, all characterized by a natural
feeling and a combination of tactility and sensoriality:
Naturale, Grana, Rigatino and Cannettato.

NATURALE	R10 — Floor / Wall	9 mm / 3/8"	
GRANA — GRIP	R11 — Floor / Wall	9 mm / 3/8"	20 mm / 3/4"
RIGATINO	R10 — Floor / Wall	9 mm / 3/8"	
CANNETTATO	Rivestimento / Wall	9 mm / 3/8"	

NATURALE





RIGATINO

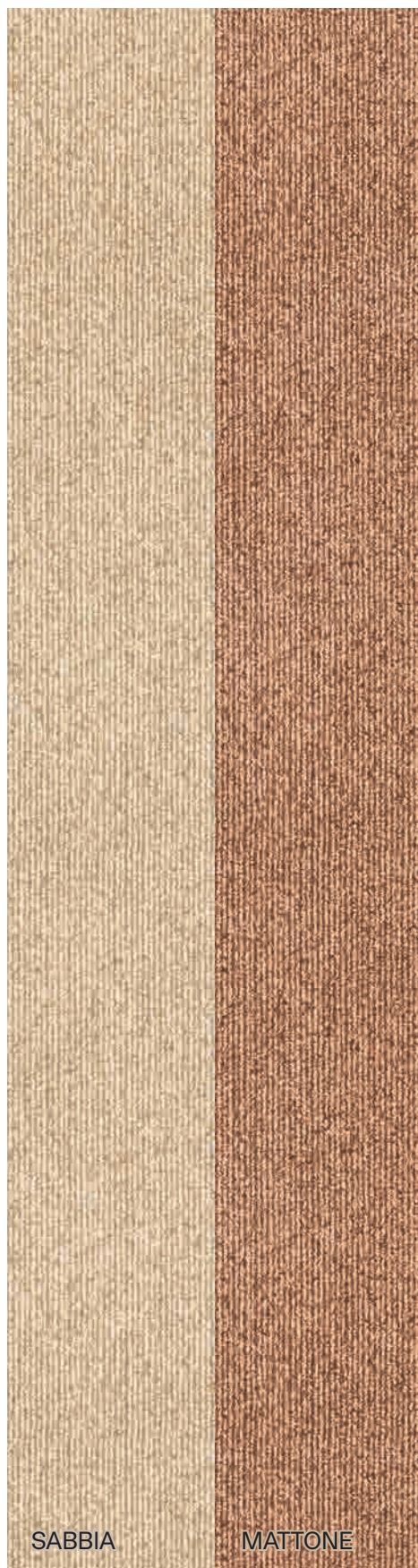

CANNETTATO



SIZES

Versatilità e modularità sono le chiavi di lettura di SensiTerre che offre infinite possibilità di espressione creativa combinando i diversi elementi del progetto: dal piccolo al grande formato.

Versatility and modularity are the key aspects of SensiTerre, offering endless possibilities for creative expression by combining the different elements of the project: from small to large formats.



TILES

Un'ampia gamma di formati e diverse geometrie si declinano in 6 tonalità e quattro tipologie di superfici per rispondere a tutte le necessità del progetto.

A wide range of formats and various geometries are available in six shades and four types of surfaces to meet all project requirements.





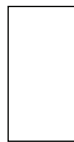
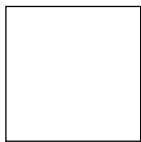

NATURALE

R10 — Floor & Wall Covering

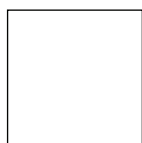



FORMATI Sizes	120×120 cm 47¼"×47¼"	60×120 cm 25½"×47¼"	80×80 cm 31½"×31½"	60×60 cm 23½"×23½"	30×60 cm 11½"×23½"	15×30 cm 6"×11½"	20×20 cm 7⅞"×7⅞"	22×20 cm 8⅝"×7⅞"
SPESSORE Thickness	9 mm / ⅜"	9 mm / ⅜"	9 mm / ⅜"	9 mm / ⅜"	9 mm / ⅜"	9 mm / ⅜"	9 mm / ⅜"	9 mm / ⅜"
COTONE	781530	781483	781524	781499	781505	781783	781792	781804
SABBIA	781531	781484	781525	781500	781507	781853	781793	781806
ROSATO	781532	781485	781526	781501	781508	781784	781794	781805



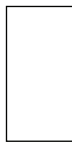

FORMATI Sizes	120×120 cm 47¼"×47¼"	60×120 cm 25½"×47¼"	80×80 cm 31½"×31½"	60×60 cm 23½"×23½"	30×60 cm 11½"×23½"	15×30 cm 6"×11½"	20×20 cm 7⅞"×7⅞"	22×20 cm 8⅞"×7⅞"
SPESSORE Thickness	9 mm / ⅜"	9 mm / ⅜"	9 mm / ⅜"	9 mm / ⅜"	9 mm / ⅜"	9 mm / ⅜"	9 mm / ⅜"	9 mm / ⅜"
 MATTONE	781533	781486	781527	781502	781509	781785	781795	781807
 AMARANTO	781534	781487	781528	781503	781510	781786	781796	781808
 CARBONE	781535	781488	781529	781504	781511	781787	781797	781809

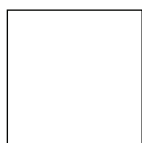

FORMATI Sizes	120×120 cm 47¼"×47¼"		60×120 cm 25½"×47¼"		60×60 cm 23½"×23½"	30×60 cm 11½"×23½"	15×30 cm 6"×11½"	20×20 cm 7⅞"×7⅞"	22×20 cm 8⅞"×7⅞"
	9 mm / ⅜"	20 mm / ¾"	9 mm / ⅜"	20 mm / ¾"	9 mm / ⅜"	9 mm / ⅜"	9 mm / ⅜"	9 mm / ⅜"	9 mm / ⅜"
 COTONE	781536	781542	781489	781548	781512	781518	781788	781798	781810
 SABBIA	781537	781543	781490	781549	781513	781519	781855	781799	781812
 ROSATO	781538	781544	781491	781550	781514	781520	781854	781800	781811





FORMATI Sizes	120×120 cm 47¼"×47¼"		60×120 cm 25½"×47¼"		60×60 cm 23½"×23½"	30×60 cm 11½"×23½"	15×30 cm 6"×11½"	20×20 cm 7⅞"×7⅞"	22×20 cm 8⅝"×7⅞"
SPESSORE Thickness	9 mm / ⅜"	20 mm / ¾"	9 mm / ⅜"	20 mm / ¾"	9 mm / ⅜"	9 mm / ⅜"	9 mm / ⅜"	9 mm / ⅜"	9 mm / ⅜"
 MATTONE	781539	781546	781492	781551	781515	781521	781789	781801	781813
 AMARANTO	781540		781493		781516	781522	781790	781802	781814
 CARBONE	781541		781494		781517	781523	781791	781803	781815

RIGATINO

R10 — Floor & Wall Covering





FORMATI Sizes	60×120 cm 25 ⁵ / ₈ "×47 ¹ / ₄ "
SPESSORE Thickness	9 mm / ³ / ₈ "
 SABBIA	781497
 MATTONE	781498



CANNETTATO

Rivestimento / Wall Covering



FORMATI Size	60×120 cm 25 $\frac{5}{8}$ "×47 $\frac{1}{4}$ "
SPESSORE Thickness	9 mm / $\frac{3}{8}$ "
 SABBIA	781495
 MATTONE	781496



CONFIGURATIONS

La gamma si completa con delle proposte di composizioni geometriche. La materia diventa decorazione con accostamenti inediti di colori, forme e superfici. I moduli, su rete, guidano e semplificano l'applicazione.

The range is completed with proposals for geometric compositions. The material becomes a decoration with unique combinations of colors, shapes, and surfaces. The modules, set on a grid, guide and simplify the application.



LISTELLO

MESH MOUNTED

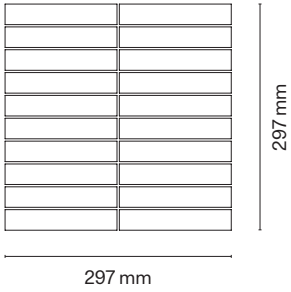

FORMATO / Size



3×15 cm
1½"×6"

CONFIGURAZIONI / Configurations



ROSATO



MATTONE



AMARANTO



CARBONE

SUPERFICIE Surface	NATURALE R10 – Floor / Wall	NATURALE R10 – Floor / Wall	NATURALE R10 – Floor / Wall	NATURALE R10 – Floor / Wall
FORMATO Size	30×30 cm 11½"×11½"	30×30 cm 11½"×11½"	30×30 cm 11½"×11½"	30×30 cm 11½"×11½"
SPESSORE Thickness	9 mm ¾"	9 mm ¾"	9 mm ¾"	9 mm ¾"
AREA	0,09 m ²	0,09 m ²	0,09 m ²	0,09 m ²
CODICE Code	781828	781829	781830	781831
	ON DEMAND		ON DEMAND	ON DEMAND



INTRECCIO

MESH MOUNTED

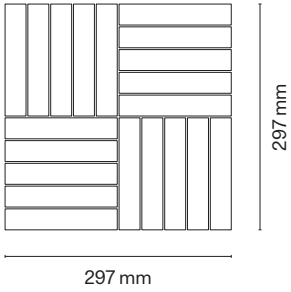

FORMATO / Size



3×15 cm
1¼"×6"

CONFIGURAZIONI / Configurations



COTONE MATTONE



MATTONE COTONE



ROSATO AMARANTO



AMARANTO ROSATO

SUPERFICIE Surface	NATURALE R10 – Floor / Wall	NATURALE R10 – Floor / Wall	NATURALE R10 – Floor / Wall	NATURALE R10 – Floor / Wall
FORMATO Size	30×30 cm 11½"×11½"	30×30 cm 11½"×11½"	30×30 cm 11½"×11½"	30×30 cm 11½"×11½"
SPESSORE Thickness	9 mm ¾"	9 mm ¾"	9 mm ¾"	9 mm ¾"
AREA	0,09 m ²	0,09 m ²	0,09 m ²	0,09 m ²
CODICE Code	781836	781837	781838	781839
	ON DEMAND	ON DEMAND	ON DEMAND	ON DEMAND



SPINA

MESH MOUNTED

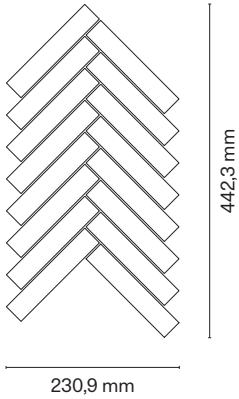

FORMATO / Size



3×15 cm
1 1/8"×6"

CONFIGURAZIONI / Configurations



ROSATO



MATTONE



AMARANTO



CARBONE

SUPERFICIE Surface	NATURALE R10 – Floor / Wall	NATURALE R10 – Floor / Wall	NATURALE R10 – Floor / Wall	NATURALE R10 – Floor / Wall
FORMATO Size	23×44 cm 19"×17 1/3"	23×44 cm 19"×17 1/3"	23×44 cm 19"×17 1/3"	23×44 cm 19"×17 1/3"
SPESSORE Thickness	9 mm 3/8"	9 mm 3/8"	9 mm 3/8"	9 mm 3/8"
AREA	0,072 m ²	0,072 m ²	0,072 m ²	0,072 m ²
CODICE Code	781824	781825	781826	781827
			ON DEMAND	ON DEMAND



TAPPETO

MESH MOUNTED

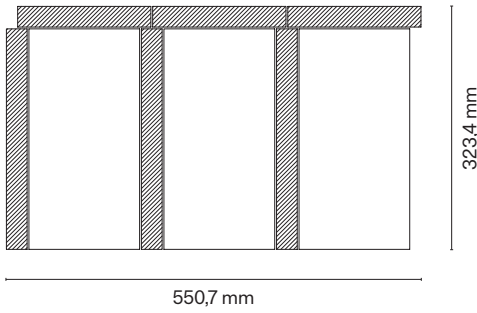

FORMATI / Sizes

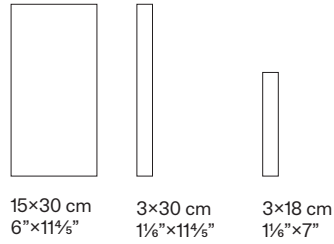

CONFIGURAZIONI / Configurations



COTONE MATTONE



MATTONE COTONE



ROSATO AMARANTO



AMARANTO ROSATO

SUPERFICIE Surface	NATURALE R10 — Floor / Wall	NATURALE R10 — Floor / Wall	NATURALE R10 — Floor / Wall	NATURALE R10 — Floor / Wall
FORMATO Size	57×69 cm 22⅝"×27⅝"	57×69 cm 22⅝"×27⅝"	57×69 cm 22⅝"×27⅝"	57×69 cm 22⅝"×27⅝"
SPESSORE Thickness	9 mm ⅜"	9 mm ⅜"	9 mm ⅜"	9 mm ⅜"
AREA	0,173 m ²	0,173 m ²	0,173 m ²	0,173 m ²
CODICE Code	781832	781833	781834	781835
			ON DEMAND	ON DEMAND

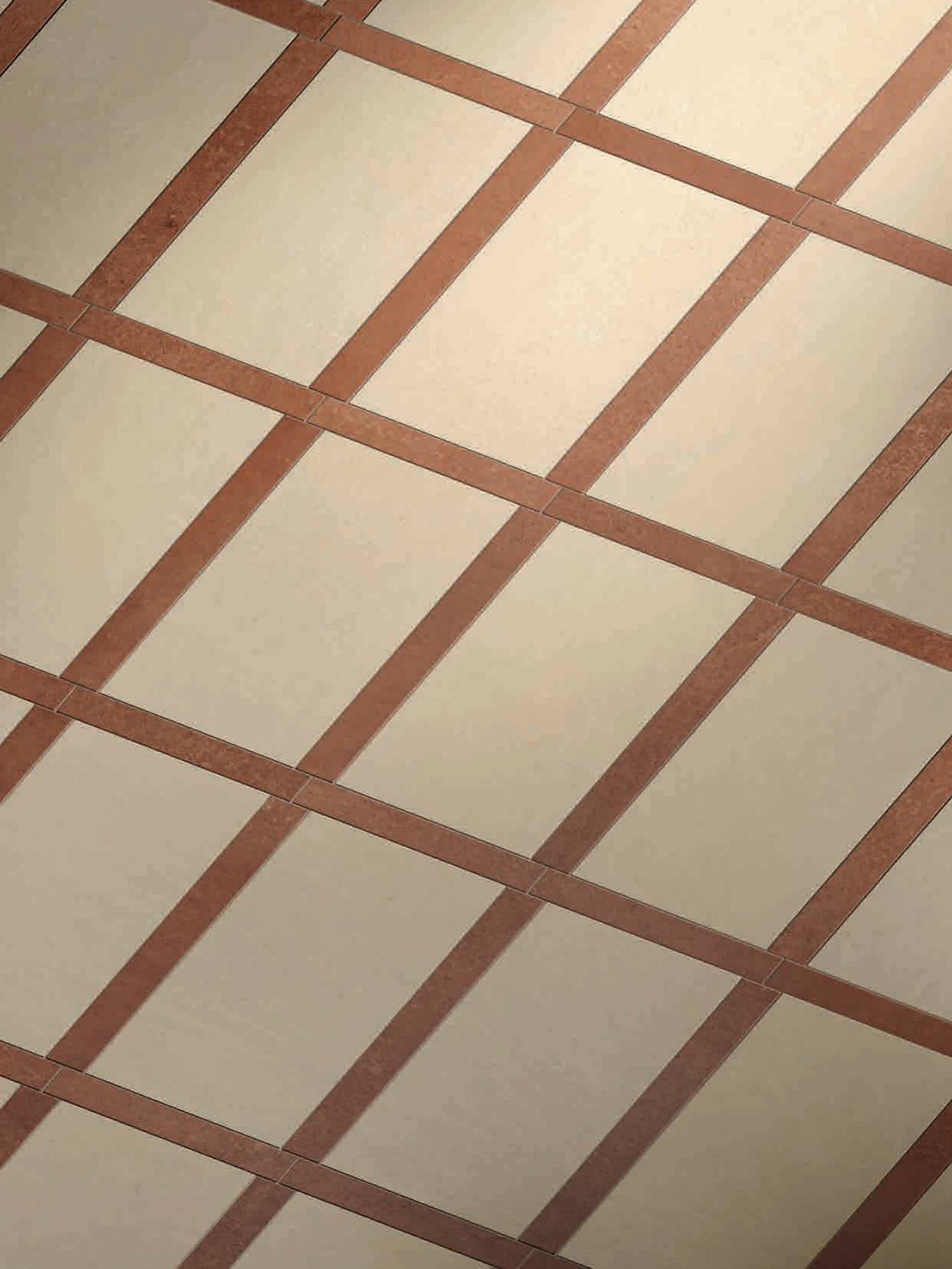

CUBO

MESH MOUNTED

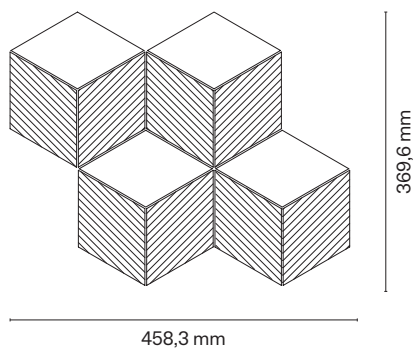

CONFIGURAZIONI / Configurations



COTONE ROSATO MATTONE



ROSATO AMARANTO CARBONE

SUPERFICIE Surface	NATURALE R10 – Floor / Wall	NATURALE R10 – Floor / Wall
FORMATO Size	37×46 cm 14 ⁴ / ₇ "×18 ¹ / ₈ "	37×46 cm 14 ⁴ / ₇ "×18 ¹ / ₈ "
SPESSORE Thickness	9 mm 3/8"	9 mm 3/8"
AREA	0,116 m ²	0,116 m ²
CODICE Code	781840	781841
	ON DEMAND	ON DEMAND



TAVELLA AND LISTELLO

MESH MOUNTED

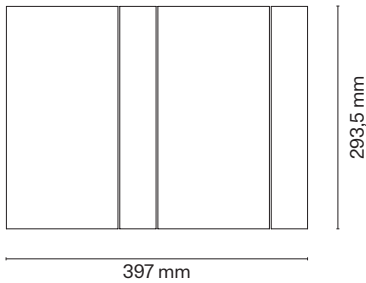

FORMATI / Sizes

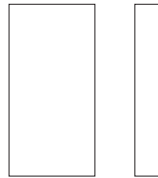

15×30 cm
6"×11½"

5×30 cm
2"×11½"

NATURALE

NATURALE

CONFIGURAZIONI / Configurations



COTONE



MATTONE



AMARANTO



CARBONE

SUPERFICIE Surface	NATURALE R10 – Floor / Wall	NATURALE R10 – Floor / Wall	NATURALE R10 – Floor / Wall	NATURALE R10 – Floor / Wall
FORMATO Size	30×40 cm 11½"×15¾"	30×40 cm 11½"×15¾"	30×40 cm 11½"×15¾"	30×40 cm 11½"×15¾"
SPESSORE Thickness	9 mm ¾"	9 mm ¾"	9 mm ¾"	9 mm ¾"
AREA	0,117 m ²	0,117 m ²	0,117 m ²	0,117 m ²
CODICE Code	781816	781817	781818	781819
	ON DEMAND	ON DEMAND	ON DEMAND	ON DEMAND

TAVELLA AND LISTELLO

MESH MOUNTED

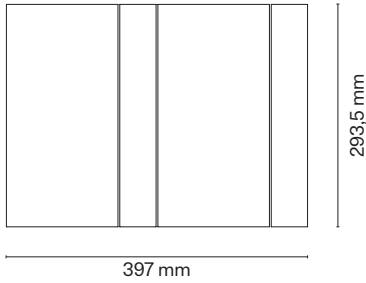

FORMATI / Sizes



15×30 cm
6"×11½"

5×30 cm
2"×11½"

NATURALE

GRANA – GRIP

CONFIGURAZIONI / Configurations



COTONE



MATTONE



AMARANTO



CARBONE

SUPERFICIE Surface	COTONE		MATTONE		AMARANTO		CARBONE	
	NATURALE R10 – F/W	GRANA – GRIP R11 – F/W	NATURALE R10 – F/W	GRANA – GRIP R11 – F/W	NATURALE R10 – F/W	GRANA – GRIP R11 – F/W	NATURALE R10 – F/W	GRANA – GRIP R11 – F/W
FORMATO Size	30×40 cm 11½"×15¾"		30×40 cm 11½"×15¾"		30×40 cm 11½"×15¾"		30×40 cm 11½"×15¾"	
SPESSORE Thickness	9 mm ¾"		9 mm ¾"		9 mm ¾"		9 mm ¾"	
AREA	0,117 m ²		0,117 m ²		0,117 m ²		0,117 m ²	
CODICE Codex	781820		781821		781822		781823	
	ON DEMAND		ON DEMAND		ON DEMAND		ON DEMAND	

TECHNICAL FEATURES



FORMATI







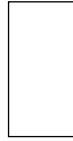

SIZES

SQUADRATO

Squared







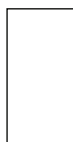
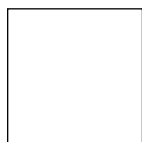

GRES FINE PORCELLANATO
Fine porcelain stoneware



FORMATI Sizes	120×120 cm 47¼"×47¼"		60×120 cm 25½"×47¼"		80×80 cm 31½"×31½"	60×60 cm 23½"×23½"	30×60 cm 11½"×23½"	15×30 cm 6"×11½"	20×20 cm 7⅞"×7⅞"	22×20 cm 8⅜"×7⅞"
SPESSORE Thickness	9mm / ⅜"	20mm / ¾"	9mm / ⅜"	20mm / ¾"	9mm / ⅜"	9mm / ⅜"	9mm / ⅜"	9mm / ⅜"	9mm / ⅜"	9mm / ⅜"
COTONE										
 NATURALE R10 Floor / Wall	781530		781483		781524	781499	781505	781783	781792	781804
 GRANA R11 Grip Floor / Wall	781536	781542	781489	781548		781512	781518	781788	781798	781810
SABBIA										
 NATURALE R10 Floor / Wall	781531		781484		781525	781500	781507	781853	781793	781806
 GRANA R11 Grip Floor / Wall	781537	781543	781490	781549		781513	781519	781855	781799	781812
 RIGATINO R10 Floor / Wall			781497							
 CANNETTATO Wall			781495							
ROSATO										
 NATURALE R10 Floor / Wall	781532		781485		781526	781501	781508	781784	781794	781805
 GRANA R11 Grip Floor / Wall	781538	781544	781491	781550		781514	781520	781854	781800	781811

GRES FINE PORCELLANATO
Fine porcelain stoneware



FORMATI Sizes	120×120 cm 47¼"×47¼"		60×120 cm 25½"×47¼"		80×80 cm 31½"×31½"	60×60 cm 23½"×23½"	30×60 cm 11½"×23½"	15×30 cm 6"×11½"	20×20 cm 7⅞"×7⅞"	22×20 cm 8⅞"×7⅞"
SPESSORE Thickness	9mm / ⅜"	20mm / ¾"	9mm / ⅜"	20mm / ¾"	9mm / ⅜"	9mm / ⅜"	9mm / ⅜"	9mm / ⅜"	9mm / ⅜"	9mm / ⅜"
MATTONE										
 NATURALE R10 Floor / Wall	781533		781486		781527	781502	781509	781785	781795	781807
 GRANA R11 Grip Floor / Wall	781539	781546	781492	781551		781515	781521	781789	781801	781813
 RIGATINO R10 Floor / Wall			781498							
 CANNETTATO Wall			781496							
AMARANTO										
 NATURALE R10 Floor / Wall	781534		781487		781528	781503	781510	781786	781796	781808
 GRANA R11 Grip Floor / Wall	781540		781493			781516	781522	781790	781802	781814
CARBONE										
 NATURALE R10 Floor / Wall	781535		781488		781529	781504	781511	781787	781797	781809
 GRANA R11 Grip Floor / Wall	781541		781494			781517	781523	781791	781803	781815

PEZZI SPECIALI

SPECIAL TRIMS

SQUADRATO

Squared

GRES FINE PORCELLANATO
Fine porcelain stoneware

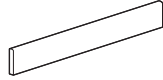



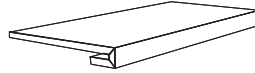

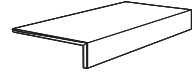

BATTISCOPIA



GRADINO



ELEMENTO ELLE

FORMATI Sizes	4,6×120 cm 1 ⁷ / ₈ "×47 ¹ / ₄ "	33×120×3 cm 13"×47 ¹ / ₄ "×1 ¹ / ₈ "	20×40×6 cm 7 ⁷ / ₈ "×15 ³ / ₄ "×2 ¹ / ₈ "
SPESSORE Thickness	9mm 3 ⁷ / ₈ "	9mm 3 ⁷ / ₈ "	9mm 3 ⁷ / ₈ "
COTONE			
 NATURALE R10	781868	781880	781881
 GRANA R11 Grip	781874	781898	781887
SABBIA			
 NATURALE R10	781869	781893	781882
 GRANA R11 Grip	781875	781899	781888
ROSATO			
 NATURALE R10	781870	781894	781883
 GRANA R11 Grip	781876	781900	781889

GRES FINE PORCELLANATO
Fine porcelain stoneware

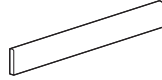

BATTISCOPA

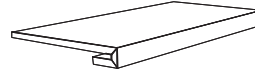

GRADINO

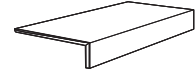

ELEMENTO ELLE

FORMATI Sizes	4,6×120 cm 1 ⁷ / ₈ "×47 ¹ / ₄ "	33×120×3 cm 13"×47 ¹ / ₄ "×1 ¹ / ₈ "	20×40×6 cm 7 ⁷ / ₈ "×15 ³ / ₄ "×2 ¹ / ₈ "
SPESSORE Thickness	9mm 3 ⁷ / ₈ "	9mm 3 ⁷ / ₈ "	9mm 3 ⁷ / ₈ "
MATTONE			
 NATURALE R10	781871	781895	781884
 GRANA R11 Grip	781877	781901	781890
AMARANTO			
 NATURALE R10	781872	781896	781885
 GRANA R11 Grip	781878	781902	781891
CARBONE			
 NATURALE R10	781873	781897	781886
 GRANA R11 Grip	781879	781903	781892

SENSI TERRE OUTDOOR

Vantaggi tecnici - Technical advantages - Avantages techniques Technische Vorteile - Ventajas técnicas

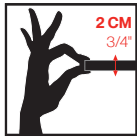

- Lastra monolitica compatta di spessore 2 cm squadrata e rettificata.
- Compact monolithic slab 2 cm thick squared and rectified.
- Dalle monolithique compacte de 2 cm d'épaisseur, équarrie et rectifiée.
- Kompakte monolithische Platte, 2 cm dick, rechtwinklig und scharfkantig geschliffen.
- Losa monolítica compacta de 2 cm de espesor, escuadrada y rectificada.



- INGELIVO
- FROST RESISTANT
- INGÉLIF
- FROSTBESTÄNDIG
- RESISTENTE A LA HELADA

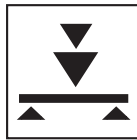

- ELEVATA RESISTENZA AI CARICHI STATICI
- HIGH STATIC LOAD RESISTANCE
- RÉSISTANCE ÉLEVÉE AUX CHARGES STATIQUES
- HOHE STATISCHE BELASTBARKEIT
- ELEVADA RESISTENCIA A LAS CARGAS ESTÁTICAS

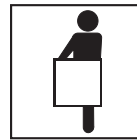

- FACILE DA POSARE
- EASY TO INSTALL
- FACILE À POSER
- VERLEGELEICHT
- FÁCIL DE COLOCAR



- ANTISCIVOLO R11
- ANTI SLIP R11
- ANTIDÉRAPANT R11
- RUTSCHFEST R11
- ANTIDESLIZANTE R11

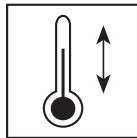

- RESISTENTE AGLI SBALZI TERMICI
- THERMAL SHOCK RESISTANT
- RÉSISTANT AUX ÉCARTS THERMIQUES
- TEMPERATURWECHSELBESTÄNDIG
- RESISTENTE A LAS OSCILACIONES TÉRMICAS

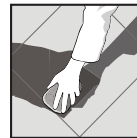

- FACILE DA PULIRE
- EASY TO CLEAN
- FACILE À NETTOYER
- REINIGUNGSLEICHT
- FÁCIL DE LIMPIAR

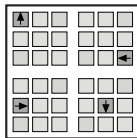

- RIMOVIBILE E RIUTILIZZABILE
- REMOVABLE AND REUSABLE
- DÉMONTABLE ET RÉUTILISABLE
- ENTFERNBAR UND WIEDERVERWENDBAR
- DESMONTABLE Y REUTILIZABLE



- INATTACCABILE DA AGENTI CHIMICI E MUFFE
- IMPERVIOUS TO ATTACK BY CHEMICALS OR MOULD
- RÉSISTANT AUX AGENTS CHIMIQUES ET AUX MOISSISSURES
- UNANGREIFBAR DURCH CHEMISCHE STOFFE UND SCHIMMEL
- RESISTENTE A LOS AGENTES QUÍMICOS Y A LOS MOHOS

Applicazioni - Applications - Applications - Verlegung - Aplicaciones

- Posa diretta su erba
- Direct installation on grass
- Pose direct sur de l'herbe
- Verlegung direkt auf Rasen
- Colocación directa sobre hierba

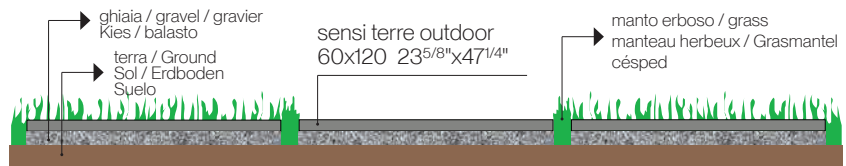

- Posa diretta su ghiaia
- Direct installation over gravel
- Pose direct sur du gravier
- Verlegung direkt auf Kies
- Colocación directa sobre grava

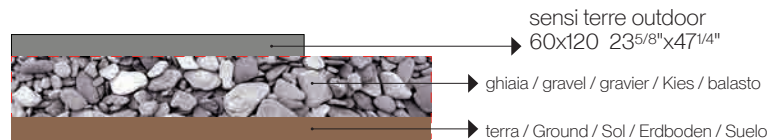

- Posa su massetto cementizio
- Installation on sand-cement screed
- Pose sur chape ciment
- Verlegung auf Zement-Unterbetonblock
- Colocación sobre contrapiso de hormigón

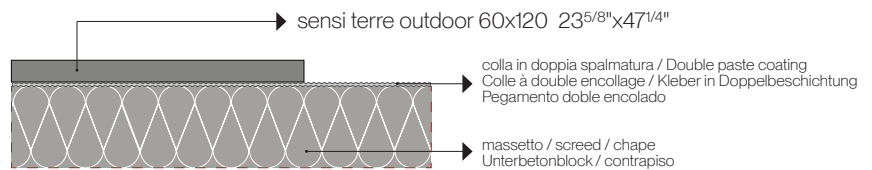

- Posa su piedini fissi o regolabili
- Installation on fixed or adjustable feet
- Pose sur pieds fixes ou réglables
- Verlegung auf feststehende oder regulierbare Füße
- Colocación sobre pies fijos o regulables

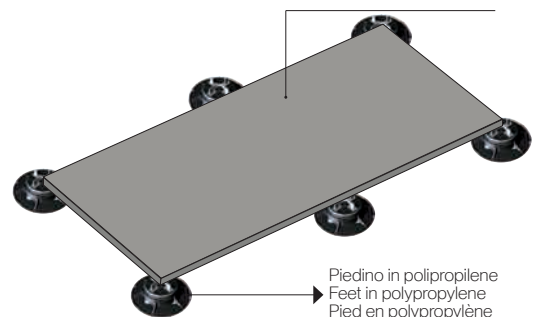









Per le specifiche di utilizzo dei sistemi sopraelevati vedi il sito florim.com
For the specifics on use of raised systems visit the site florim.com
Pour les caractéristiques d'utilisation des systèmes surélevés, voir le site florim.com
Für die Nutzungsbedingungen der Doppelbodensysteme siehe Webseite florim.com
Para las especificaciones de empleo de los sistemas sobreelevados consulte el sitio web florim.com

Le lastre ceramiche sono sottoposte a un trattamento di compattazione termica che assicura resistenza e durata nel tempo. Il bassissimo assorbimento d'acqua rende perciò il materiale ingelivo. Ciò può comportare ristagni d'acqua superficiali anche per materiale installato a regola d'arte. / Ceramic tiles undergo a compacting thermal treatment that ensures resistance and durability. The low level of water absorption makes the slabs frost resistant. This could result in superficial water stagnations even if materials are installed in a workmanlike manner. / Les carreaux de céramique subissent un traitement thermique de compactage qui assure résistance et durabilité. Le bas niveau d'absorption d'eau rend les dalles résistant au gel. Il pourrait en résulter des stagnations d'eau superficielles, même si les dalles ont été installées dans les règles de l'art. / Die Keramikplatten werden einer thermischen Verdichtung unterzogen, welche die Widerstandsfähigkeit und Langlebigkeit sichert. Die extrem niedrige Wasseraufnahme macht das Material frostsicher. Die hohe Materialdichte kann, auch bei einer perfekten Verlegung, eine längere Abtrochnungszeit von angestaumtem Wasser zur Folge haben. / Las baldosas cerámicas se someten a un tratamiento de compactación térmica que asegura resistencia y durabilidad. La baja absorción de agua hace que las baldosas resistan al hielo. Esto podría resultar en estancamientos superficiales de agua, incluso si los materiales están instalados según las reglas del arte.

CARATTERISTICHE TECNICHE - TECHNICAL CHARACTERISTICS - CARACTERISTIQUES TECHNIQUES - TECHNISCHE EIGENSCHAFTEN - CARACTERÍSTICAS TÉCNICAS						
		PRESCRIZIONE STANDARD REQUIREMENTS PRESCRIPTIONS ANFORDERUNGEN PRESCRIPCION		RISULTATI TESTS TEST RESULTS RESULTATS DES ESSAIS PRÜFERGEBNIS RESULTADOS TESTS	RIFERIMENTO NORMA REFERENCE STANDARD REFERENCIA NORME STANDARDWERT REFERENCIA NORMA	
		N > 15 cm				
		(%)	(mm)	grip		
	LUNGHEZZA E LARGHEZZA: DEVIAZIONE AMMISSIBILE, IN % DELLA DIMENSIONE MEDIA DI OGNI PIASTRELLA DALLA DIM DI FABBRICAZIONE / LENGTH AND WIDTH: ADMITTED DEVIATION, IN % OF THE AVERAGE SIZE OF EACH TILE FROM THE PRODUCTION / DIMENSIONS / LONGUEUR ET LARGEUR - MARGE DE TOLERANCE, EN % ENTRE LA DIMENSION MOYENNE DE CHAQUE CARREAU ET LA DIM. DE FABRICATION / LÄNGE UND BREITE: ZULÄSSIGE ABWEICHUNG DES DURCHSCHNITTMÄßES JEDER FLIESE VOM HERSTELLMAß IN PROZENTEN / LARGO Y ANCHO: DESVIACION ADMISIBILE, EN % DEL TAMAÑO MEDIO DE CADA BALDOSA A PARTIR DEL TAMAÑO DE FABRICACION.	Squadrato ISO 13006	±0,3 %	±10 mm	±0,15 %	ISO 10545-2
	DEVIAZIONE AMMISSIBILE, IN PERCENTO, DELLO SPESSORE MEDIO DI OGNI PIASTRELLA DALLA DIMENSIONE DI FABBRICAZIONE / ADMITTED DEVIATION, IN % OF THE AVERAGE THICKNESS OF EACH TILE FROM THE PRODUCTION DIMENSIONS / MARGE DE TOLERANCE, EN POURCENTAGE, ENTRE L'ÉPAISSEUR MOYENNE DE CHAQUE CARREAU ET LA DIMENSION DE FABRICATION / ZULÄSSIGE ABWEICHUNG DER DURCHSCHNITTSDICKE JEDER FLIESE VOM HERSTELLMAß IN PROZENTEN / DESVIACION ADMISIBILE, EN TANTO POR CIENTO, DEL GROSOR MEDIO DE CADA BALDOSA A PARTIR DEL TAMAÑO DE FABRICACION.	Squadrato ISO 13006	±5 %	±0,5 mm	±5 %	
	DEVIAZIONE MASSIMA DI RETTILINEARITÀ, IN PERCENTO, IN RAPPORTO ALLE DIMENSIONI DI FABBRICAZIONE CORRESPONDENTI / MAXIMUM STRAIGHTNESS DEVIATION, IN % IN RELATION TO THE CORRESPONDING PRODUCTION DIMENSIONS / MARGE DE TOLERANCE DE RECTITUDE, EN POURCENTAGE, PAR RAPPORT AUX DIMENSIONS DE FABRICATION CORRESPONDANTES / ZULÄSSIGE HOCHSTABWEICHUNG DER KANTENGERADHEIT IM VERHÄLTNIß ZU DEN ENTSPRECHENDEN HERSTELLMAßEN IN PROZENTEN / DESVIACION MÁXIMA DE RECTITUD, EN TANTO POR CIENTO, EN RELACION CON EL TAMAÑO DE FABRICACION CORRESPONDIENTE.	Squadrato ISO 13006	±0,3 %	±0,8 mm	±0,10 %	
	DEVIAZIONE MASSIMA DI ORTOGONALITÀ, IN PERCENTO, IN RAPPORTO ALLE DIMENSIONI DI FABBRICAZIONE CORRESPONDENTI / MAXIMUM RIGHT-ANGLE DEVIATION, IN % IN RELATION TO THE CORRESPONDING PRODUCTION DIMENSIONS / MARGE DE TOLERANCE D'ANGULARITÉ, EN POURCENTAGE, PAR RAPPORT AUX DIMENSIONS DE FABRICATION / HOCHSTABWEICHUNG DER RECHTWINKLIGKEIT IM VERHÄLTNIß ZU DEN ENTSPRECHENDEN HERSTELLMAßEN IN PROZENTEN / DESVIACION MÁXIMA DE LA ORTOGONALIDAD, EN TANTO POR CIENTO, EN RELACION CON EL TAMAÑO DE FABRICACION CORRESPONDIENTE.	Squadrato ISO 13006	±0,3 %	±1,5 mm	±0,2 %	
	PLANARITÀ (CURVATURA DEL CENTRO, DELLO SPIGOLO E SVERGOLAMENTO) / FLATNESS (CURVING IN THE MIDDLE, CORNER AND WARPING) / PLANÉTIE (COUBURE CENTRALE, DE L'ARÊTE ET GAUCHISSEMENT) / EBENFLÄCHIGKEIT (KRÜMMUNG DER MITTE, DER KANTE UND VERWINDUNG) / PLANITUD (CURVATURA DEL CENTRO, DE LA ARISTA Y ABRUQUILLAMIENTO).	Squadrato ISO 13006	±0,4 %	±1,8 mm	±0,35 %	
	QUALITÀ DELLA SUPERFICIE - SURFACE QUALITY / QUALITÉ DE LA SURFACE - QUALITÄT DER OBERFLÄCHE / CALIDAD DE LA SUPERFICIE.				CONFORME/CONFORMING CONFORME/KONFORM CONFORME.	
	MASSA D'ACQUA ASSORBITA IN % / WATER ABSORPTION - MASSE D'EAU ABSORBÉE EN % / WASSERAUFNAHME IN % / MASA DE AGUA ABSORBIDA EN %		E ≤ 0,5 %		valore medio 0,08 %	ISO 10545-3
	FORZA DI ROTTURA IN N (sp. ≥ 7,5 mm) - BREAKING STRENGTH IN N (thickness ≥ 7,5 mm) / FORCE DE RUPTURE EN N (ép. ≥ 7,5 mm) / BRUCHLAST IN N (Dicke ≥ 7,5 mm) / FUERZA DE ROTURA EN N (gr. ≥ 7,5 mm)		≥ 1300 N		valore medio 12000 N	ISO 10545-4
	RESISTENZA ALLA FLESSIONE IN N/mm² / FLEXURAL STRENGTH TEST / RÉSISTANCE À LA FLEXION EN N/mm² / BIEGEFESTIGKEIT IN N/mm² / RESISTENCIA A LA FLEXION EN N/mm²		> 35 N/mm²		valore medio 52 N/mm²	ISO 10545-4
	RESISTENZA ALL'ABRASIONE PROFONDA DELLE PIASTRELLE NON SMALTATE / RESISTANCE TO DEEP ABRASION OF UNGLAZED TILES / RESISTENCIA A LA ABRASION PROFUNDA DE LAS BALDOSAS SIN ESMALTAR		< 175 mm³		valore medio 140 mm³	ISO 10545-6
	RESISTENZA AGLI SBALZI TERMICI / THERMAL SHOCKS RESISTANT / RÉSISTANCE AUX VARIATIONS THERMIQUES TEMPERATUREWECHELBESTÄNDIGKEIT / RESISTENCIA AL CHOQUE TÉRMICO.		-		RESISTE - RÉSISTANT RÉSISTE - ERFÜLLT RESISTE	ISO 10545-9
	RESISTENZA ALLE MACCHIE / RESISTANCE TO STAINING / RÉSISTANCE AUX TACHES / FLECKENABWEISEND RESISTENCIA A LAS MANCHAS		Metodo di prova disponibile Available testing method Méthode d'essai disponible Verfügbare Prüfmethode Método de ensayo disponible		Classe 4	ISO 10545-14
	RESISTENZA A BASSE CONCENTRAZIONI DI ACIDI E ALCALI / RESISTANCE TO LOW CONCENTRATIONS OF ACIDS AND ALKALIS / RESISTANCE À BASSES CONCENTRATIONS D'ACIDES ET ALCALIS / WIDERSTAND GEGEN NIEDRIGE KONZENTRATIONEN VON SÄUREN UND LAUGEN / RESISTENCIA A BAJAS CONCENTRACIONES DE ÁCIDOS Y ALCALIS.		COME DICHIARATO DAL PRODUTTORE SEE MANUFACTURERS DECLARATION SELON DECLARATION DU PRODUCTEUR ENTSPRECHEND DER HERSTELLERANGABEN TAL COMO DECLARA EL FABRICANTE		HA LA	ISO 10545-13
	RESISTENZA A ALTE CONCENTRAZIONI DI ACIDI ED ALCALI / RESISTANCE TO HIGH CONCENTRATIONS OF ACIDS AND ALKALI / RÉSISTANCE À DE HAUTES CONCENTRATIONS D'ACIDES ET BASES / BESTÄNDIGKEIT GEGEN STARK KONZENTRIERTE SÄUREN UND LAUGEN / RESISTENCIA A ALTAS CONCENTRACIONES DE ÁCIDOS Y ALCALIS		B min		A	
	RESISTENZA AL GELO / FROST RESISTANCE - RÉSISTANCE AU GEL / FROSTSICHERHEIT - RESISTENCIA A LA HELADA		RICHIESTA / REQUIRED REQUIRE / GEFORDERT REQUERIDA		RESISTE - RÉSISTANT RÉSISTE - ERFÜLLT RESISTE	ISO 10545-12
	COEFFICIENTE D'ATTRITO (SCIVOLOSITÀ) / FRICTION COEFFICIENT (SLIPPERINESS) / COEFFICIENT DE FRICTION (GLISSEMENT) / REIBUNGSKOEFFIZIENT (SCHLÜPFRIEGKEIT) - COEFICIENTE DE ANTI DESLIZAMIENTO				> 0,40 > 0,42 wet 19° < α ≤ 27° R11 α ≥ 24° classe C PTV > 36 WET	METODO BCRA ANSI A 326.3 DIN EN 16165 ANNEX B DIN EN 16165 ANNEX A BS EN 16165 ANNEX C

Per un effetto ottimale della posa, florim suggerisce di mantenere 2 mm di fuga per pose monofornate e 3 mm per combinare formati misti / For optimal installation results, florim recommends maintaining a joint of 2 mm 1/16" for single format installations and 3 mm 1/8" to combine mixed formats / Pour réaliser une pose parfaite, florim suggère de maintenir 2 mm de joint pour la pose des monofornats, et 3 mm pour les combinaisons de formats mixtes / Um einen optimalen effekt beim verlegen zu erzielen empfiehlt florim eine 2 mm fuge bei einformatigen verlegungen und 3 mm fuge bei formatkombinationen / Para lograr los máximos resultados en la posa del producto, florim aconseja 2 mm de juntas en aplicaciones monofornato y 3 mm en combinaciones de formatos mixtos.

CARATTERISTICHE TECNICHE - TECHNICAL CHARACTERISTICS - CARACTERISTIQUES TECHNIQUES - TECHNISCHE EIGENSCHAFTEN - CARACTERÍSTICAS TÉCNICAS		PRESCRIZIONE STANDARD REQUIREMENTS PRESCRIPTIONS ANFORDERUNGEN PRESCRIPTION		RISULTATI TESTS TEST RESULTS RESULTATS DES ESSAIS PRÜFERGEBNIS RESULTADOS TESTS				RIFERIMENTO NORMA REFERENCE STANDARD REFERENCIA NORME STANDARDWERT REFERENCIA NORMA
		N > 15 cm		naturale	cannettato	rigatino	grana	
		(%)	(mm)					
	LUNGHEZZA E LARGHEZZA: DEVIAZIONE AMMISSIBILE, IN % DELLA DIMENSIONE MEDIA DI OGNI PIASTRELLA DALLA DIM. DI FABBRICAZIONE / LENGTH AND WIDTH: ADMITTED DEVIATION, IN % OF THE AVERAGE SIZE OF EACH TILE FROM THE PRODUCTION DIMENSIONS / LONGUEUR ET LARGEUR: MARGE DE TOLERANCE, EN % ENTRE LA DIMENSION MOYENNE DE CHAQUE CARREAU ET LA DIM. DE FABRICATION / LÄNGE UND BREITE: ZULÄSSIGE ABWEICHUNG DES DURCHSCHNITTMÄßES JEDER FLIESE VOM HERSTELLMAß IN PROZENTEN / LARGO Y ANCHO: DESVIACION ADMISIBILE, EN %, DEL TAMAÑO MEDIO DE CADA BALDOSA A PARTIR DEL TAMAÑO DE FABRICACION.	Squadrato ISO 13006	±0,3 %	±10 mm			±0,15 %	
	DEVIAZIONE AMMISSIBILE, IN PERCENTO, DELLO SPESORE MEDIO DI OGNI PIASTRELLA DALLA DIMENSIONE DI FABBRICAZIONE / ADMITTED DEVIATION, IN % OF THE AVERAGE THICKNESS OF EACH TILE FROM THE PRODUCTION DIMENSIONS / MARGE DE TOLERANCE, EN POURCENTAGE, ENTRE L'ÉPAISSEUR MOYENNE DE CHAQUE CARREAU ET LA DIMENSION DE FABRICATION / ZULÄSSIGE HOCHSTABWEICHUNG DER DURCHSCHNITTSSTÜCKE JEDER FLIESE VOM HERSTELLMAß IN PROZENTEN / DESVIACION ADMISIBILE, EN TANTO POR CIENTO, DEL GROSOR MEDIO DE CADA BALDOSA A PARTIR DEL TAMAÑO DE FABRICACION.	Squadrato ISO 13006	±5 %	±0,5 mm			±5 %	
	DEVIAZIONE MASSIMA DI RETTILINEARITÀ, IN PERCENTO, IN RAPPORTO ALLE DIMENSIONI DI FABBRICAZIONE CORRISPONDENTI / MAXIMUM STRAIGHTNESS DEVIATION, IN %, IN RELATION TO THE CORRESPONDING PRODUCTION DIMENSIONS / MARGE DE TOLERANCE DE RECTITUDE, EN POURCENTAGE, PAR RAPPORT AUX DIMENSIONS DE FABRICATION / HOCHSTABWEICHUNG DER RECHTWINKLIGKEIT IM VERHÄLTNIS ZU DEN ENTSPRECHENDEN HERSTELLMAßEN IN PROZENTEN / DESVIACION MÁXIMA DE RECTITUD, EN TANTO POR CIENTO, EN RELACION CON EL TAMAÑO DE FABRICACION CORRESPONDIENTE.	Squadrato ISO 13006	±0,3 %	±0,8 mm			±0,10 %	ISO 10545-2
	DEVIAZIONE MASSIMA DI ORTOGONALITÀ, IN PERCENTO, IN RAPPORTO ALLE DIMENSIONI DI FABBRICAZIONE CORRISPONDENTI / MAXIMUM RIGHT-ANGLE DEVIATION, IN %, IN RELATION TO THE CORRESPONDING PRODUCTION DIMENSIONS / MARGE DE TOLERANCE D'ANGULARITÉ, EN POURCENTAGE, PAR RAPPORT AUX DIMENSIONS DE FABRICATION / HOCHSTABWEICHUNG DER RECHTWINKLIGKEIT IM VERHÄLTNIS ZU DEN ENTSPRECHENDEN HERSTELLMAßEN IN PROZENTEN / DESVIACION MÁXIMA DE LA ORTOGONALIDAD, EN TANTO POR CIENTO, EN RELACION CON EL TAMAÑO DE FABRICACION CORRESPONDIENTE.	Squadrato ISO 13006	±0,3 %	±1,5 mm			±0,20 %	
	PLANARITÀ (CURVATURA DEL CENTRO, DELLO SPIGOLO E SVERGOLAMENTO) / FLATNESS (CURVING IN THE MIDDLE, CORNER AND WARPING) / PLANÉTÉ (COUURE CENTRALE, DE L'ARÊTE ET GAUCHISSEMENT) / EBENFLÄCHIGKEIT (KRÜMMUNG DER MITTE, DER KANTE UND VERWINDUNG) / PLANITUD (CURVATURA DEL CENTRO, DE LA ARISTA Y ABARUILLAMIENTO).	Squadrato ISO 13006	±0,4 %	±1,8 mm			±0,35 %	
	QUALITÀ DELLA SUPERFICIE - SURFACE QUALITY / QUALITÉ DE LA SURFACE - QUALITÄT DER OBERFLÄCHE / CALIDAD DE LA SUPERFICIE.						CONFORME/CONFORMING CONFORME/KONFORM CONFORME.	
	MASSA D'ACQUA ASSORBITA IN % / WATER ABSORPTION - MASSE D'EAU ABSORBÉE EN % / WASSERAUFNAHME IN % / MASA DE AGUA ABSORBIDA EN %		Es0,5 %				valore medio 0,08 %	ISO 10545-3
	FORZA DI ROTTURA IN N (sp. ≥ 7,5 mm) - BREAKING STRENGTH IN N (thickness ≥ 7,5 mm) / FORCE DE RUPTURE EN N (ép. ≥ 7,5 mm) / BRUCHLAST IN N (Dicke ≥ 7,5 mm) / FUERZA DE ROTURA EN N (gr. ≥ 7,5 mm)		≥1300 N				valore medio 2200 N	ISO 10545-4
	RESISTENZA ALLA FLESSIONE IN N/mm ² / N/mm ² FLEXURAL STRENGTH TEST / RÉSISTANCE A LA FLEXION EN N/mm ² / BIEGEFESTIGKEIT IN N/mm ² / RESISTENCIA A LA FLEXIÓN EN N/mm ²		>35 N/mm ²				valore medio 50 N/mm ²	ISO 10545-4
	RESISTENZA ALL'ABRAZIONE PROFONDA DELLE PIASTRELLE NON SMALTATE / RESISTANCE TO DEEP ABRASION OF UNGLAZED TILES / RESISTANCE A L'ABRASION PROFONDE DES CARREAUX NON ÉMAILLÉS / TIEFENABRIEFESTIGKEIT UNGLASIRTER FLIESEN / RESISTENCIA A LA ABRASION PROFUNDA DE LAS BALDOSAS SIN ESMALTAR		<175 mm ³				valore medio 140 mm ³	ISO 10545-6
	RESISTENZA AGLI SBALZI TERMICI / THERMAL SHOCKS RESISTANT / RÉSISTANCE AUX VARIATIONS THERMIQUES TEMPERATURWECHSELBESTÄNDIGKEIT / RESISTENCIA AL CHOQUE TÉRMICO.		-				RESISTE - RÉSISTANT RESISTE - ERFÜLLT RESISTE	ISO 10545-9
	RESISTENZA ALLE MACCHIE / RESISTANCE TO STAINING / RÉSISTANCE AUX TACHES / FLECKENABWEISEND RESISTENCIA A LAS MANCHAS		Metodo di prova disponibile Available testing method Méthode d'essai disponible Verfügbare Prüfmethode Método de ensayo disponible				Classe 4	ISO 10545-14
	RESISTENZA A BASSE CONCENTRAZIONI DI ACIDI E ALCALI / RESISTANCE TO LOW CONCENTRATIONS OF ACIDS AND ALKALIS / RESISTANCE A BASSES CONCENTRATIONS D'ACIDES ET ALCALIS / WIDERSTAND GEGEN NIEDRIGE KONZENTRATIONEN VON SÄUREN UND LAUGEN / RESISTENCIA A BAJAS CONCENTRACIONES DE ÁCIDOS Y ALCALIS.						LA	ISO 10545-13
	RESISTENZA A ALTE CONCENTRAZIONI DI ACIDI ED ALCALI / RESISTANCE TO HIGH CONCENTRATIONS OF ACIDS AND ALKALI / RESISTANCE A HAUTES CONCENTRATIONS D'ACIDES ET BASES / BESTÄNDIGKEIT GEGEN STARK KONZENTRIERTE SÄUREN UND LAUGEN / RESISTENCIA A ALTAS CONCENTRACIONES DE ÁCIDOS Y ALCALIS						HA	
	RESISTENZA AI PRODOTTI CHIMICI DI USO DOMESTICO E AGLI ADDITIVI PER PISCINA / RESISTANCE TO DOMESTIC CHEMICAL PRODUCTS AND ADDITIVES FOR SWIMMING POOLS / RESISTANT AUX PRODUITS CHIMIQUES À USAGE DOMESTIQUE ET AUX ADDITIFS POUR PISCINE / WIDERSTAND GEGEN HAUSHALTSCHIMIKALIEN UND SCHWIMMBADZUSATZSTOFFEN / RESISTENCIA A PRODUCTOS PARA LIMPIEZA DOMESTICA Y ADITIVOS PARA PISCINAS		B min				A	
	RESISTENZA AL GELO / FROST RESISTANCE - RESISTANCE AU GEL / FROSTSICHERHEIT - RESISTENCIA A LA HELADA		RICHIESTA / REQUIRED REQUIRE / GEFORDET REQUERIDA				RESISTE - RÉSISTANT RESISTE - ERFÜLLT RESISTE	ISO 10545-12
	COEFFICIENTE D'ATTRITO (SCIVOLosità) / FRICTION COEFFICIENT (SLIPPERINESS) / COEFFICIENT DE FRICTION (GLISSEMENT) / REIBUNGSKOEFFIZIENT (SCHLÜPFIGKEIT) - COEFFICIENTE DE ANTI DESLIZAMIENTO						> 0,40 > 0,42 wet 10° < α ≤ 19° R10 10° < α ≤ 19° R10 10° < α ≤ 19° R10 19° < α ≤ 27° R11 18° ≤ α < 24° classe B 18° ≤ α < 24° classe B 18° ≤ α < 24° classe B α ≥ 24° classe C PTV >36 WET	METODO BCRA ANSI A 326.3 DIN EN 16165 ANNEX B DIN EN 16165 ANNEX A BS EN 16165 ANNEX C

Per un effetto ottimale della posa, florim suggerisce di mantenere 2 mm di fuga per pose monofornate e 3 mm per combinare formati misti / For optimal installation results, florim recommends maintaining a joint of 2 mm 1/16" for single format installations and 3 mm 1/8" to combine mixed formats / Pour réaliser une pose parfaite, florim suggère de maintenir 2 mm de joint pour la pose des monofornats, et 3 mm pour les combinaisons de formats mixtes / Um einen optimalen effekt beim verlegen zu erzielen empfiehlt florim eine 2 mm fugen bei einformatigen verlegungen und 3 mm fugen bei formatkombinationen / Para lograr los máximos resultados en la posa del producto, florim aconseja 2 mm de juntas en aplicaciones monofornato y 3 mm en combinaciones de formatos mixtos.

FLORIM

Un'innata passione per la **bellezza** e una grande **determinazione** ci hanno portato a sfidare i luoghi comuni riuscendo a trasformare ciò che tutti chiamano piastrella da oggetto funzionale ad **elemento di design**. Un passato di oltre **60 anni**, radicato nel distretto ceramico di Sassuolo (MO), si lega ad un presente da trendsetter internazionale.

An innate passion for **beauty** and great **determination** have led us to challenge clichés, succeeding in transforming what everyone calls tile into an **element of design**.
With over **60 years** of history rooted in the Sassuolo ceramic district (MO), we are now a global trendsetter in the industry.



FLORIM

MADE IN FLORIM

La ricerca della bellezza fa parte del patrimonio genetico dell'essere umano

In Florim questo istinto per la creatività si fonde con la passione e incontra la più moderna tecnologia produttiva per dar vita ad un nuovo tipo di prodotto. Un progetto morale non solo bello ma anche a basso impatto ambientale e pensato per far star bene le persone nel loro spazio. Abbiamo una lunga storia da raccontare e una gran voglia di guardare avanti in un futuro fatto di **bellezza, innovazione e sostenibilità**.

ALTAGAMMA

La bellezza e lo stile italiani nel mondo

Vocazione estetica, heritage culturale e forte identità sono alcuni degli elementi condivisi da Florim e Altagama, la Fondazione che dal 1992 riunisce le **imprese ambasciatrici dello stile italiano nel mondo**. Una comunione di vedute che ha permesso a Florim di essere accolta nel 2022 come nuovo membro.

La Fondazione racchiude l'élite delle aziende italiane votate all'alto di gamma: il segmento di mercato in costante crescita in tutto il mondo e nel quale il Made in Italy gioca un ruolo da protagonista. Altagama riunisce i marchi più prestigiosi nei settori moda, design, gioielleria, alimentare, ospitalità, motori e nautica.

CARBONZERO

Le superfici Carbon Neutral di Florim

In linea con la nostra strategia che sposa un **paradigma di business a beneficio del pianeta**, dal 2023 promuoviamo CarbonZero: il progetto di superfici Carbon Neutral che compensano le emissioni di CO₂ generate dalla loro produzione e dal loro ciclo di vita.

Misuriamo

Abbiamo calcolato l'impatto ambientale delle nostre superfici **lungo il ciclo di vita del prodotto*** perché vogliamo ridurre tutte le emissioni di CO₂, anche quelle che avvengono al di fuori dell'azienda.

Riduciamo

Per contenere le emissioni della nostra attività, **abbiamo ridotto l'uso di risorse naturali** e investito per rendere il processo produttivo **più sostenibile**: fino al 100% in termini di acqua, energia elettrica e recupero degli scarti crudi.

Compensiamo

Promuoviamo un impatto positivo: le collezioni CarbonZero **compensano tutta la CO₂ emessa durante il loro ciclo di vita**, supportando progetti certificati che producono energia pulita nei paesi in via di sviluppo. Il progetto CarbonZero unisce alla consueta bellezza e al design dei prodotti Florim l'impatto positivo dato dalla compensazione di CO₂**.

(*) dato certificato EPD – numero di registrazione EPDITALY0462

(**) la compensazione avviene attraverso l'acquisto di crediti di carbonio CER (Certified Emission Reductions) sul registro CDM (Clean Development Mechanism) dell'UNFCCC (United Nations Framework for Climate Change). per il calcolo è stato utilizzato il valore di 19,05 kg di CO₂-eq / m² con densità media di 21,97 kg/m² – dato calcolato partendo dal valore di GWP total (EPD Florim che considera l'intero ciclo di vita del prodotto) integrando le attività di manutenzione e pulizia ipotizzando una durata di 60 anni. Florim si impegna annualmente nel monitoraggio, riduzione e compensazione delle emissioni di gas ad effetto serra delle collezioni CarbonZero.

MADE IN FLORIM

The pursuit of beauty is part of the human genetic heritage

At Florim, this instinct for creativity merges with passion and meets the most advanced production technology to create a new kind of product. A moral project that is not only beautiful but also environmentally friendly, designed to enhance well-being in personal spaces with a low environmental impact. We have a long story to tell and a strong desire to look forward to a future built on **beauty, innovation, and sustainability**.

ALTAGAMMA

Italian beauty and style around the world

Aesthetic vocation, cultural heritage, and a strong identity are key elements shared by Florim and Altagamma, the foundation that since 1992 has brought together **companies that represent Italian style worldwide**. This shared vision led to Florim's induction as a new member in 2022. The Foundation includes the elite of Italian companies dedicated to the **high-end segment** - a market that continues to grow globally, where Made in Italy plays a leading role. Altagamma brings together the most prestigious brands in fashion, design, jewelry, food, hospitality, automotive, and yachting.

CARBONZERO

Florim's Carbon Neutral surfaces

Aligned with our strategy of embracing a **business paradigm that benefits the planet**, in 2023 we launched CarbonZero: an initiative dedicated to Carbon Neutral surfaces that fully offset the CO₂ emissions produced throughout their manufacturing and lifecycle.

We measure

We have calculated the environmental impact of our surfaces **along the product life cycle** (*) because we aim to reduce all CO₂ emissions, including those that occur outside.

We reduce

To contain the emissions from our activity, **we have reduced the use of natural resources** and invested in making the production process **more sustainable**: up to 100% in terms of water, electricity, and raw waste recovery.

We offset

We promote a positive impact: CarbonZero collections **offset all the CO₂ emitted during their life cycle**, supporting certified projects that produce clean energy in developing countries. The CarbonZero project combines beauty and design with the positive impact given by CO₂ offsetting (**).

(*) EPD certified data – registration number EPDITALY0462

(**) Offsetting is achieved through the purchase of CER (Certified Emission Reductions) carbon credits on the CDM (Clean Development Mechanism) registry of the UNFCCC (United Nations Framework for Climate Change). For the calculation, a value of 19.05 kg of CO₂-eq / m² with an average density of 21.97 kg/m² was used – this data was calculated starting from the total GWP value (EPD Florim that considers the entire life cycle of the product) integrating maintenance and cleaning activities assuming a lifespan of 60 years. Florim commits annually to monitoring, reducing, and offsetting the greenhouse gas emissions of the CarbonZero Collections.

I CINQUE ELEMENTI DELLA NOSTRA SOSTENIBILITÀ

ACQUA, ARIA, TERRA E FUOCO.

Consideriamo i quattro elementi naturali come risorse uniche e preziose perché dal loro equilibrio dipende la sopravvivenza degli ecosistemi.

Certified



Corporation

Siamo Società
Benefit e certificati
B Corp dal 2020.

Il nostro compito è quello di proteggerli attraverso azioni quotidiane che, sommate, fanno la differenza.

Ci piace pensare alla persona come “quinto elemento”, tassello determinante per cambiare lo stato di crisi del nostro pianeta attraverso gesti consapevoli e scelte responsabili. In Florim, le nostre persone sono ambasciatrici di un modo di fare attento e consapevole. Sono il nostro DNA, rappresentano una cultura aziendale fondata sul rispetto e la valorizzazione, che si estende a tutte le persone del territorio.

Un impegno verso le persone e l'ambiente che Florim ha preso molto seriamente, è scritto nel nostro statuto.

ACQUA

100%
riciclo
delle acque
reflue di
produzione

In Florim **tutte le acque reflue del ciclo produttivo sono riutilizzate al 100%**.
Nei nostri stabilimenti sono presenti delle **vasche di raccolta dell'acqua piovana** che recuperano l'acqua proveniente dalle precipitazioni. Per ottimizzare l'utilizzo delle risorse idriche abbiamo introdotto delle innovative **linee di squadratura a secco** che eliminano l'acqua utilizzata per la rettifica del materiale.

ARIA

100%
autoproduzione
dell'energia
elettrica
necessaria

Ci stiamo impegnando a ridurre al massimo le emissioni generate dal nostro processo e dal nostro prodotto. Possiamo contare su **127.000 mq di superfici ricoperte da impianti fotovoltaici** in grado di generare una potenza di picco di 12,3 MWp e due impianti di cogenerazione che ci permettono di autoprodurre fino al 100% dell'energia elettrica necessaria alle sedi italiane. Quando la luce del sole non basta, **acquistiamo energia elettrica proveniente esclusivamente da fonti rinnovabili certificate.**

TERRA

100%
riciclo
degli scarti
crudi di
produzione

Il nostro prodotto accoglie **oltre il 90% di materie prime di origine naturale** di altissima qualità. Riciogliamo il 100% degli scarti crudi di produzione e monitoriamo attentamente la catena di fornitura delle materie prime. I prodotti Florim accolgono **fino al 60% di materie prime riciclate**, la percentuale varia in base agli spessori e alle collezioni.

FUOCO

100%
processo
certificato
ISO 9001
per la
qualità,
50001 per
l'energia,
14001 per
l'ambiente

Il fuoco è l'elemento che cambia la materia e rende il prodotto ceramico **resistente** all'umidità, all'usura, agli agenti chimici e atmosferici. Il nostro gres viene cotto a circa 1200 gradi, questo lo rende un **materiale che dura nel tempo, sicuro e igienico.**
Una qualità testimoniata da **numerose certificazioni di prodotto e processo.**

THE FIVE ELEMENTS OF OUR SUSTAINABILITY

WATER, AIR, EARTH, AND FIRE.

We conceive the four natural elements as unique and precious resources because the survival of ecosystems depends on their balance.

Our role is to protect them through daily actions that, when combined, make a difference.

We like to think of people as the “fifth element”, a crucial piece in changing the current crisis of our planet through conscious actions and responsible choices. At Florim, our people are ambassadors of a mindful and attentive way of working. They are our DNA, embodying a corporate culture rooted in respect and appreciation, extending to everyone in our community.

This commitment to people and the environment is one that Florim takes very seriously—it’s written into our bylaws.

Certified



Corporation

We are a **Benefit Corporation** and have been certified as a **B Corp** since 2020.

ACQUA

100%
recycling
of greenware
waste

At Florim, **all wastewater from the production cycle is 100% reused.** Our facilities are equipped with **rainwater collection tanks** that capture water from precipitation. To optimize water resource usage, we have introduced innovative **dry squaring lines** that eliminate the need for water in the material rectification process.

ARIA

100%
self-production
of the
required
electrical
energy

We are committed to minimizing emissions generated by our processes and products. We have **127,000 square meters of surfaces covered with photovoltaic** systems capable of generating a peak power of 12.3 MWp, along with two cogeneration plants that allow us to self-produce up to 100% of the electricity needed for our Italian facilities. When sunlight is not enough, **we purchase electricity exclusively from certified renewable sources.**

TERRA

100%
riciclo
degli scarti
crudi di
produzione

Our products are made with **over 90% high-quality natural raw materials.** We recycle 100% of raw production waste and closely monitor our raw material supply chain. Florim products **contain up to 60% recycled raw materials,** with the percentage varying depending on thickness and collections.

FUOCO

100% Our
process is
100% certified:
ISO 9001 for
quality, ISO
50001 for
energy
management,
and ISO 14001
for
environmental
management

Fire is the element that transforms matter, making ceramic products **resistant** to moisture, wear, and chemical and atmospheric agents. Our porcelain stoneware is fired at around 1200 degrees, **making it a durable, safe, and hygienic material.** This quality is backed by **numerous product and process certifications.**

CREDITI

Quanto contenuto nel catalogo è indicativo e non esaustivo riguardo alle grafiche, decori e ai colori riportati.

Contents of this catalog is indicative and not exhaustive with regard to graphics, decors and colors shown.

Photo Credits

Marco Bertolini

Benedetto Fasciana

Collection by

Matteo Thun & Benedetto Fasciana

Catalogue by

Matteo Thun & Partners

Prima stampa settembre 2024

MADE IN FLORIM

Cod. 841741



Florim Ceramiche S.p.A. SB

Via Canaletto, 24 / 41042 Fiorano Modenese (MO) / T. +39 0536 840111 / florim.com